

# ZP 150 230V 50HZ

COD: BZP0150000B01

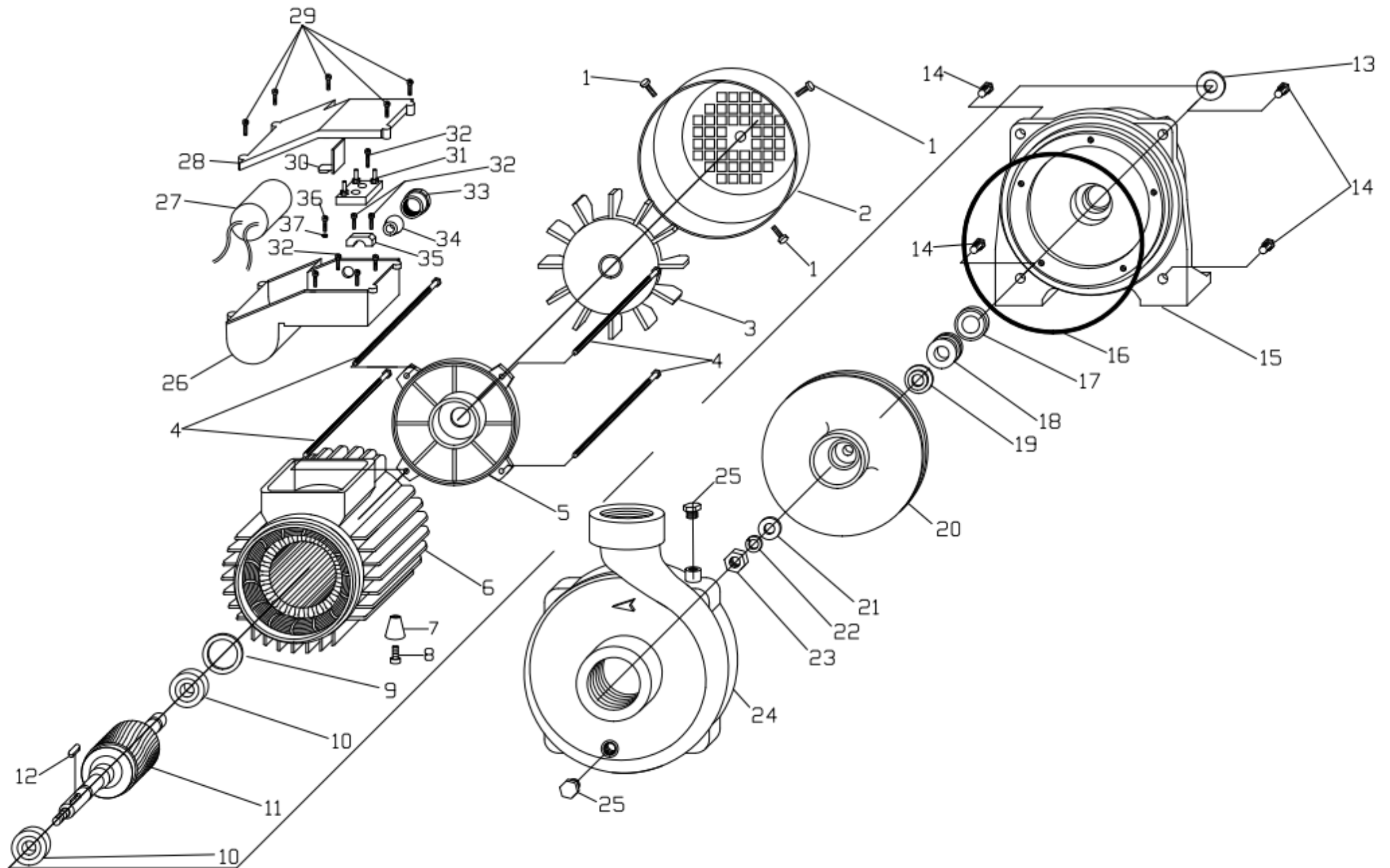

RIF.	COD. ARTICOLO	DESCRIZIONE	QUANTITA'
1	30003Z0000020	VITE M 3,5X 9,5 C15 ZNB TC+ AUTOFILET.	4
2	44BCOP8000001	COPRIVENTOLA MEC80 LAM.LUCIDA VP/4F	1
3	24BVEN0000005	VENTOLA MEC80 CON ANELLO FB	1
4	33005G0000005	TIRANTE M 5X152 4,8 GR	4
5	50BSCU8000001	SCUDO M80 B3 NPF LAV.	1
6	M822000006101	STAT IN CASSA 80 B5 AP 230/50ST.A 100	1
7	00PIE00000011	PIEDINO X MOTORE MEC71 H31 CON FORO	1
8	30005Z0000029	VITE 5,5X14 C15B ZNC TC+ AUTOFILETT.	1
9	216204C000001	ANELLO COMPENSATORE D.47 X 6204	1
10	2162040000004	CUSCINETTO 6204 2RS 20X47X14	2
11	H801000000005	ALBERO E ROTORE ZP150-ZP200(12005)	1
12	30L0400000001	LINGUETTA 4X4X10 INOX DIN 6885-A	1
13	34ROM000000001	ROMPIGOCCIA 30X14 H2,5 NBR	1
14	30010Z0000002	VITE M10 X30 8.8 ZNC TE PG DIN 933	4
15	54BSUPJET0001	SUPPORTO B-JET 88013/L LAV.GHISA	1
16	3417100000001	OR 171 X3,53 NBR 70 2312	1
17	3516F00000004	TENUTA F. 29,5X16 X8 PF C XP	1
18	3515R00000004	TENUTA R.15X32X13 PR/PN BPFF-F MOLLA L	1
19	32013BPT00001	RONDELLA PREM 13-15X30 H9 OT /	1
20	56BBZP0000003	GIRANTE H4,4 D.145 53021/L SX L. OTT	1
21	32010A0000001	RONDELLA M10 A2 DIN125-A	1
22	32010AGR00001	RONDELLA GROW M10 A2 DIN127-B	1
23	31010A0000001	DADO M10 H8 A2 DIN 934	1
24	54BTZP0000001	TESTATA GHISA ZP 150/300 LAV. 28005/L1	1
25	31TAP000000006	TAPPO 1/4 GAS E.17 OT NIC SEDE OR+OR H13	2
26	24BBAS0000001	BASE G4 MEC 80/100 SAVIPLAST M20	1
27	10CON00000023	CONDENSATORE MF 35 VL450 45 X94,5	1
28	24BCOP8000002	COPERCHIO CONDENSATORE M80 G4 M20	1
29	30003Z0000010	VITE 3,5X16 ZNC TCB+AC AUTOFIL.DIN7981	5
30	24BSTA0000001	STAFFA FERMACONDENS.M63/71/80 SAV.STA.00	1
31	11MORS0000001	MORSETTIERA 40X25 3P. + DADI	1
32	30003Z0000006	VITE 3,5X13 C15 ZNC TC+ AUTOF.DIN7981	7
33	24BGHI0000001	GHIERA FILETTATA M20X1,5 SCATOLA MEC 80	1
34	34GUA00000014	GUARN. CONICA M80/100 SAVIPLAST D. 9 M20	1
35	24BFER0000002	FERMACAVO MEC 80/100	1
36	30003Z0000005	VITE 3,5X10 C15 ZNC TC+ DIN 7500-C	1
37	32004ZDT00001	RONDELLA DENT M.4 DIN 6798 A ZNC	1